



**HONBIKE**

# Owner's Manual

EN15194  
UL2849

## IMPORTANT

This manual contains important information regarding the safe operation and maintenance of your bicycle. Read all sections before you ride your new Honbike, and carefully follow the instructions. If you have any questions or do not understand something in this manual, take responsibility for your safety and consult Honbike. Keep your owner's manual and any other documents that came with your Honbike for future reference. All content in this update and the manual is subject to change or withdrawal without notice. Visit [www.honbike.com](http://www.honbike.com) to view and download the latest version. Honbike makes every effort to ensure the accuracy of its documentation and assumes no responsibility or liability if any errors or inaccuracies appear within. This manual is not intended as a comprehensive use, service, repair or maintenance guide.

## WARNING

Riding any type of bicycle involves risks which can't be predicted or avoided and that are the sole responsibility of the rider. This manual makes no representations about the safe use of bicycles under all conditions. Off road riding, jumping or acrobatic tricks can cause frame damage which may result in death or serious injury of the rider. It is the sole responsibility of the rider to become properly educated and prepared to ride safely.

Pay particular attention to the following symbols:



### WARNING

Indicates a potentially dangerous situation that, if not avoided, could result in injury or death.



### CAUTION

Indicates a potentially dangerous situation that, if not avoided, could result in damage to the bicycle or the voiding of your warranty.



### SAFETY INSTRUCTION

Indicates specific safety instructions or procedures on how to handle the product, or refers to the section of the operating instructions that deserves your special attention.



You can visit Honbike website or Honbike official APP to get more information about the product and after-sales support. Please search [www.honbike.com](http://www.honbike.com) or scan the QR code to download APP.

## TABLE OF CONTENTS

General information .....	1
What's in the box .....	1
Accessories & Tools .....	2
Frame number .....	4
Key features .....	5
Get your Honbike ready .....	6
Unboxing .....	6
Mount the rear wheel & rear fender .....	8
Lifting the stem .....	10
Install folding pedal .....	11
How to fold/unfold the pedal.....	12
Assemble the saddle kit .....	13
Saddle height adjustment.....	14
How to use the folding stand .....	15
Install the battery .....	16
Fold your Honbike .....	17
Unfolding .....	20
Recommended torque values .....	22
Getting started .....	23
Display operations .....	24
Display advanced settings .....	24
Pedal assist level .....	26
Battery .....	27
Charging the battery.....	27
Removing the battery.....	28
Battery & Charger safety information .....	29
Proper frame sizing .....	30
Intended use .....	31
Road conditions suitable for this model .....	31
Maximum permitted overall weight .....	32
How to increase riding mileage .....	32
Before the first ride .....	33
Before every ride .....	35
Safety .....	36
The basics .....	36

# What's in the box

- Safe riding .....37
- Riding in bad weather conditions .....38
- Riding in low light conditions .....38
- Maintaining your Honbike ..... 39
- Service interval .....40
- Replacing parts .....41
- Maintenance notes .....41
- Warranty .....42
- Register your Honbike .....42
- Warranty notes .....43
- Exclusions .....44
- Special notes .....44
- Disclaimer .....45
- Declaration of conformity .....45
- FCC Compliance Statement for USA .....45
- Prop 65 Warning .....46
- Liability Disclaimer .....46
- Legal.....47

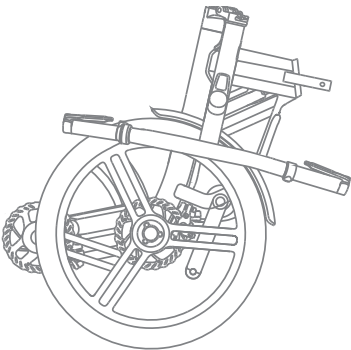

Folding bicycle \* 1

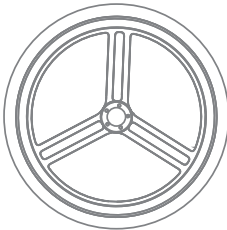

Rear wheel \* 1



Saddle & Seat Post set \*1

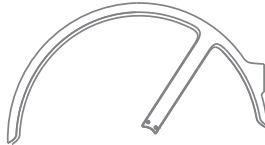

Rear fender \* 1

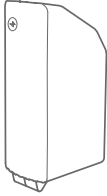

Battery \*1



Frame strap \*1

# Accessories & Tools



Rear wheel bolt cover \* 1

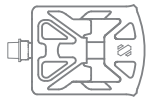

Folding pedal \* 2

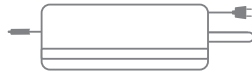

Charger & cable \* 1



Battery key \* 4



M5  
9pcs



M6  
5pcs



Hex Key

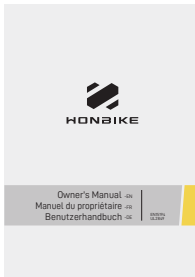

Owner's Manual

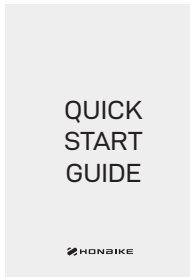

Quick Start Guide

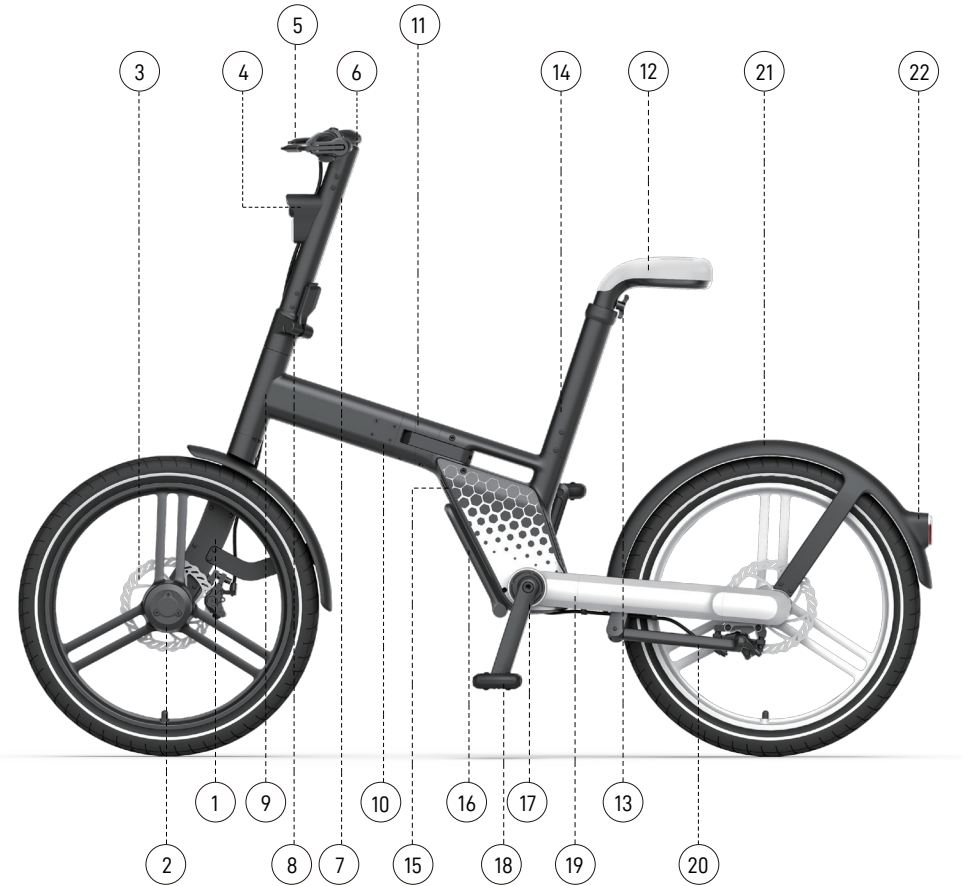

- |                          |                          |
|--------------------------|--------------------------|
| 1. Front Fork            | 12. Seat                 |
| 2. Motor                 | 13. Seat Post Lock       |
| 3. Disc Brake            | 14. Seat Tube            |
| 4. Front Light/Reflector | 15. Battery              |
| 5. Brake Lever           | 16. Folding Stand        |
| 6. Display               | 17. Crank                |
| 7. Stem                  | 18. Folding Pedal        |
| 8. Stem Hinge            | 19. Drive Shaft          |
| 9. Head Tube             | 20. Kickstand            |
| 10. Frame                | 21. Rear Fender          |
| 11. Frame Hinge          | 22. Rear Light/Reflector |

**i** After unpacking, please take all items out of the package and make sure that everything listed above is included. If anything is missing or damaged, please contact Honbike immediately for assistance.

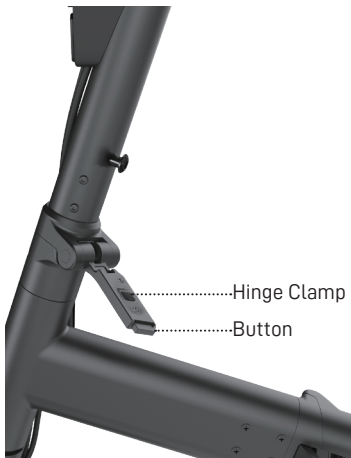

Hinge Clamp  
Button



Frame Hinge

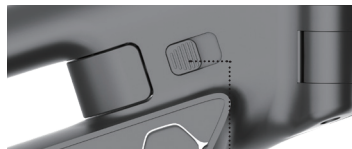

Safety Lock



Folding Stand Release

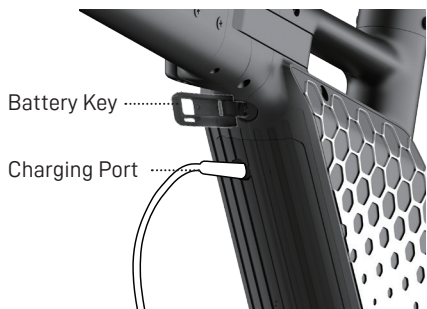

Battery Key  
Charging Port

Battery

## Frame number

Location: Head Tube

Example: 24872XXXXXXXXXX

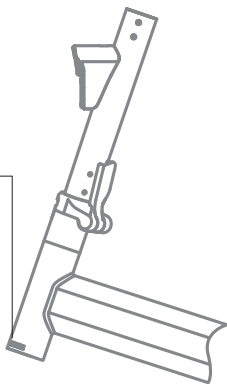

## Key features



Honbike Patented Shaft Drive System  
Fully enclosed drivetrain  
Easy Maintenance



Handlebar Integrated display  
LCD screen  
Built-in bluetooth  
Riding status display

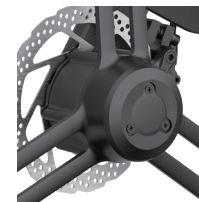

250W front hub motor  
Light weight  
High efficiency  
High reduction ratio 14:1

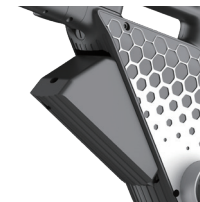

Removable battery  
Light weight  
Support ON/OFF bicycle charging

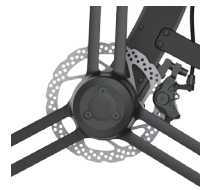

Brake  
Front & Rear disc brake



Foldable design  
Quickly folds in 15s  
Compact size, Easy storage

# Unboxing

Visit [www.honbike.com](http://www.honbike.com) to view corresponding videos to install and use HF01 correctly. Honbike packaging is delicately designed for safe transportation of the electric bicycle. We recommend that you keep Honbike original packaging at least one month in case you need to send your Honbike HF01 for service or maintenance.

 Please assemble the bicycle on a smooth indoor surface or carpet to avoid scratching it.

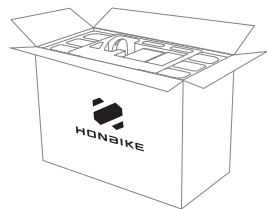

1. Open the carton carefully and try not to damage it.

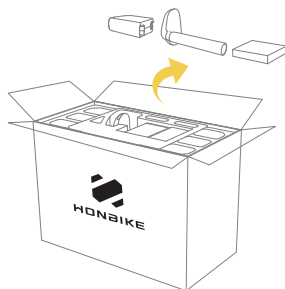

2. Take out the accessory box, battery and saddle kit separately and put them aside for later use.



3. Take out the upper foam to assist bicycle assembly.

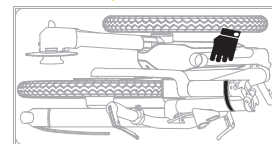
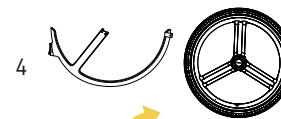

4. Take out the rear fender.  
5. Lift the bicycle with one hand while taking the rear wheel out with the other hand, be careful to avoid scratching the paint.

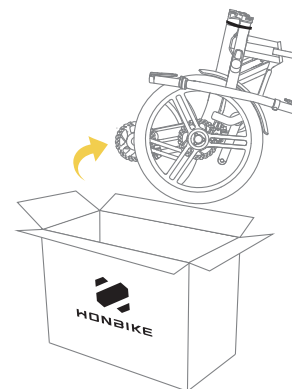

6. Take the bicycle out of the carton, unfold the bicycle frame clockwise and place it on the foam.

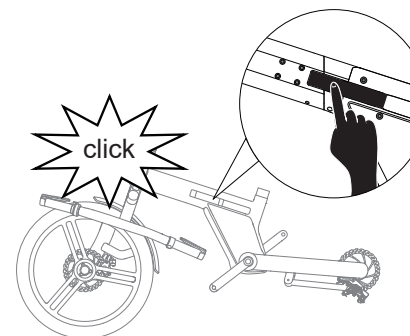

7. Use your palm or thumb to push the frame hinge to the bicycle body until hearing a "click", indicating the frame hinge is locked.

 keep fingers out of the frame hinge.



8. Lay the bicycle onto the foam.

## Mount the rear wheel & rear fender



H4

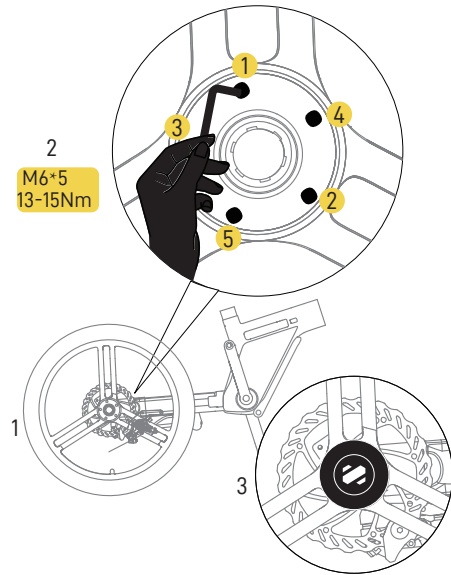

1. Place the unpainted side of the center of the rear wheel onto the bicycle.

2. Loosely tighten the five M6 bolts to the rear wheel using Hex key #4, then firmly tighten each bolt alternating in a diagonal order until all bolts are firmly tightened.

**i** Failure to tighten the bolts in diagonal order can lead to an untrue wheel.

3. Snap on the rear wheel bolt cover.

4  
M5\*1  
4-6Nm

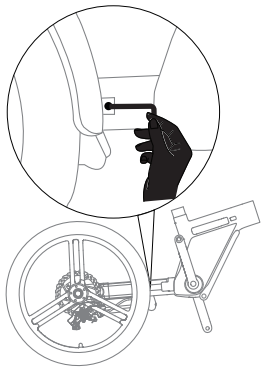

4. Install the bolt on the front side of the rear fender to the drive shaft.

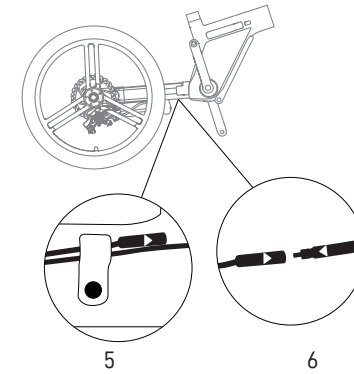

5. Run the rear light cable through the cable guide by moving the brake cable aside and threading it through.

**i** You can also use the Hex key #2.5 to unscrew the bolt on the cable guide first and then run the rear light cable through.

6. Align the rear light cable arrows and connect the ends together, tuck the cable into the bottom of the battery case as far as possible.

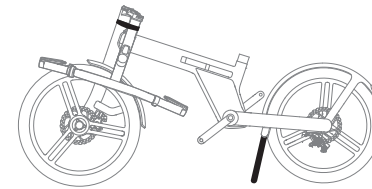

7. Stand the whole bicycle up and lower the kickstand.

M5\*2  
4-6Nm

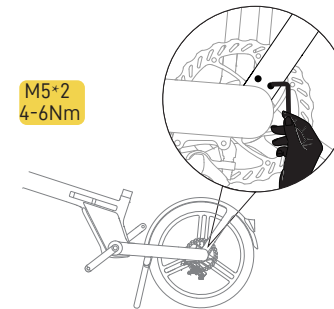

8. Install the two bolts of the rear fender stay using Hex key #4.

## Lifting the stem

 Remove the straps and the foam packaging on stem, crank and frame.

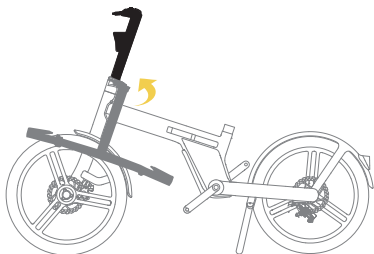

1. Flip the stem upward to the vertical position while paying attention to the brake cables. Pull the hinge clamp downward to the lowest point and continue to push the stem to the vertical position.

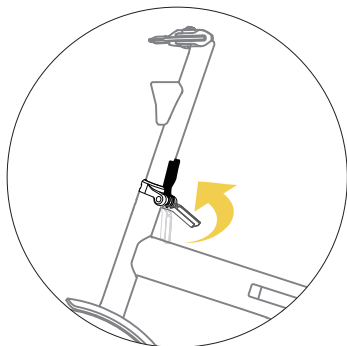

2. Lift the hinge clamp up.

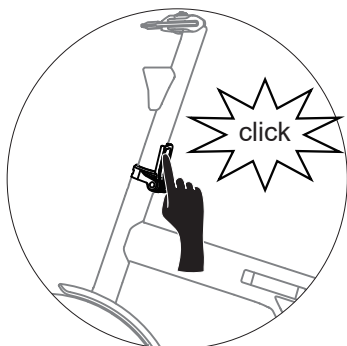

3. Firmly press the hinge clamp until hearing a "click", indicating that the hinge clamp is locked in place.

 Keep fingers out of the hinge clamp.

## Install folding pedal



H6

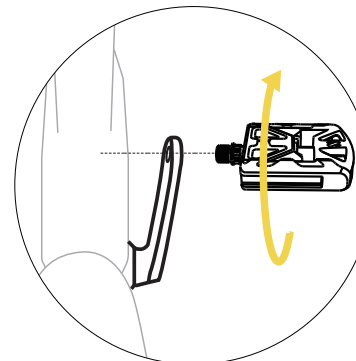

**Right:**

Take the right pedal with the label R. Screw it clockwise onto the crank by hand. Use hex key #6 to tighten it clockwise.

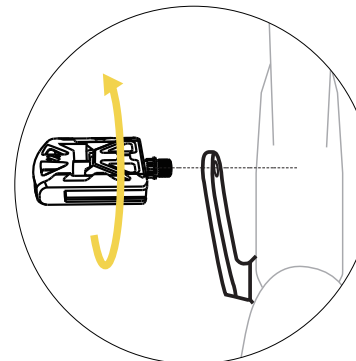

**Left:**

Take the left pedal with the label L. Screw it anticlockwise onto the crank by hand. Use hex key #6 to tighten it anticlockwise.

 Apply some anti-rust oil or grease on the pedal threads if necessary.



## How to fold the pedal

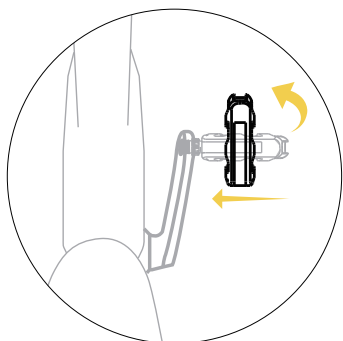

1. Place both thumbs on the crank with all other fingers on the end of the pedal.
2. Press the pedal toward the frame and then fold the pedal upward.

**i** Fold the right pedal before you fold the bicycle.

## How to unfold the pedal

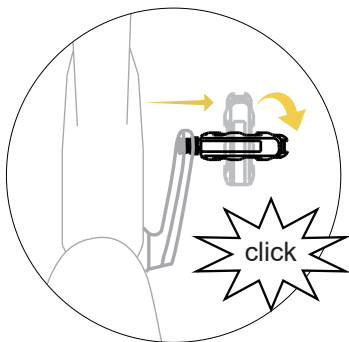

Push down on the folded part of the pedal with your palm until hearing a "click", indicating that the pedal has been unfolded in place.

## Assemble the saddle kit



H4

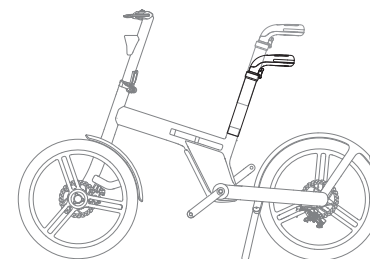

1. Put the saddle & seat post kit onto the frame.

M5\*4

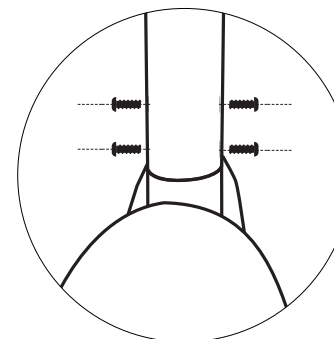

2. Align the four holes on the seat post with the four holes on the frame.

6~8 Nm

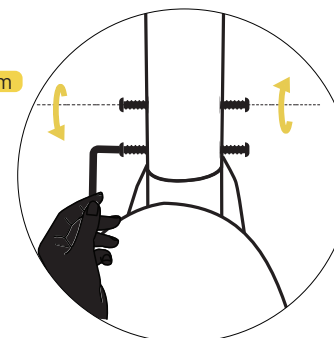

3. Tighten the four bolts clockwise. Install the lower bolts on both sides first, and then install the upper two bolts.

**i** If you find paint wear at the bolt holes of the seat tube, it is because every Honbike HF01 is fully inspected for saddle kit assembly before shipping, and this is not a quality issue.

## Saddle height adjustment

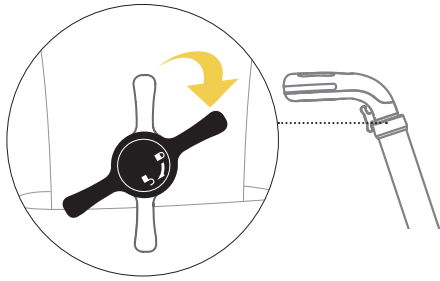

1. Turn the seat post lock clockwise.

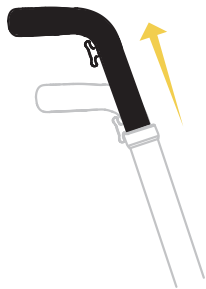

2. Lift the saddle upward to appropriate height.

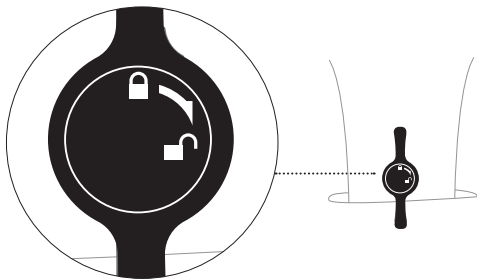

3. Tighten the seat post lock counterclockwise until it is locked perpendicular to the ground.

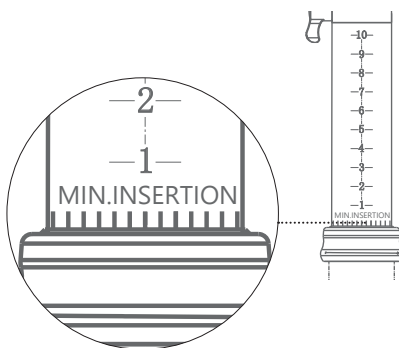

When you see the "Minimum Insertion" warning mark, the saddle has been raised to its highest position.

## How to use the folding stand



• Lower the folding stand

Pull the folding stand release inside the folding stand up to the end, then push the folding stand down until it stops.



• Lift the folding stand

Pull the folding stand release inside the folding stand to the end, and gently lift the folding stand.



If you push the folding stand without pulling the folding stand release to the end at first, the folding stand may break.

## Install the battery

- i** Pull down the folding stand before installing the battery and lift the folding stand up after the battery is well installed.

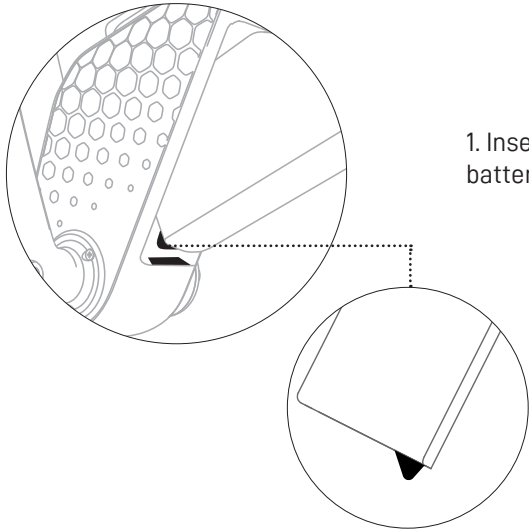

1. Insert the bulge of the battery into the battery compartment of the bicycle.

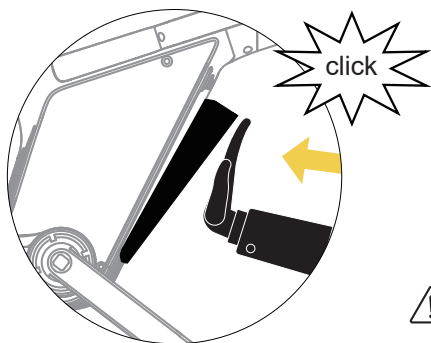

2. After the lower part of the battery is in place, push the battery toward the battery compartment until hearing a "click", indicating that the battery is well installed.

- !** Double check the battery is installed in place, otherwise the battery may drop out while riding.

## Fold your Honbike

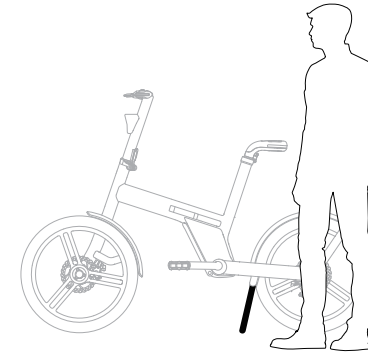

1. Stand on the left side of the bicycle. Lean the bicycle on the kickstand.

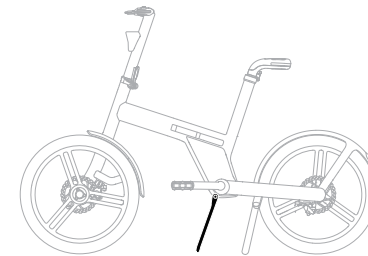

2. Pull the folding stand release inside the folding stand up to the end, then push the folding stand down until it stops.

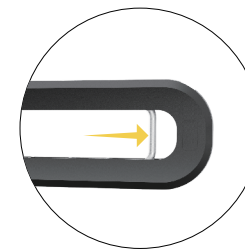

- !** If the folding stand does not reach the correct position, the bicycle may not stand securely after it is folded. In such case, please check the folding stand is pushed into the correct position.

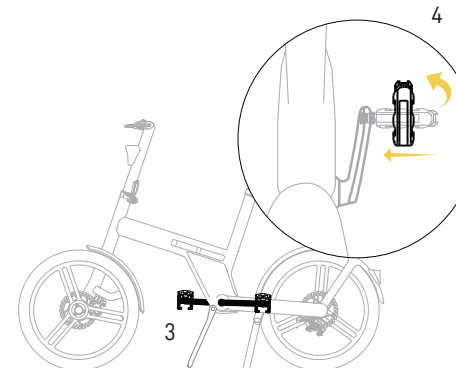

3. Rotate the right pedal counterclockwise to between 2 and 5 o'clock.

4. Place both thumbs on the crank with all other fingers on the end of the pedal. Press the pedal toward the frame and then fold the pedal upward.

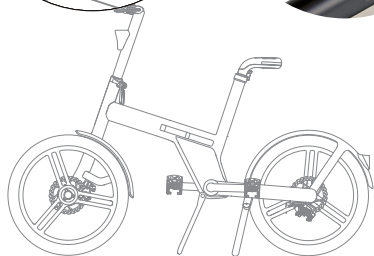
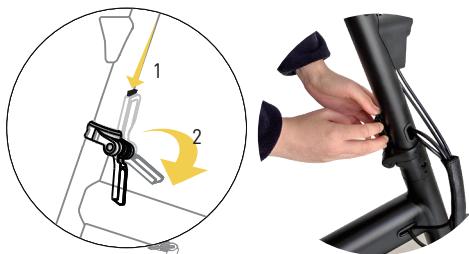

5. Press the button on the hinge clamp with your left thumb, and open the hinge clamp downward to the lowest point with both hands (increasing the force appropriately).

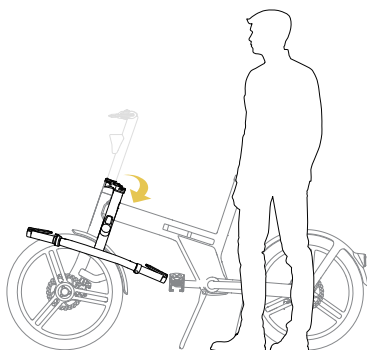

6. Fold the stem down and use your right hand to adjust the position of the brake cables to avoid interference when folding.

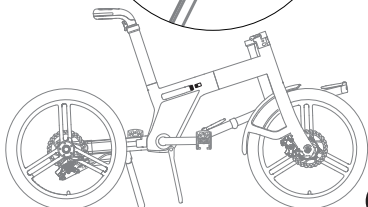
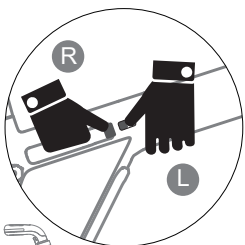

7. Use your left thumb to push the safety lock of the frame hinge toward the front of the bicycle, push it to the far-left side and keep it still, and push the frame hinge toward your body with your right hand.

**i** The bicycle may not be able to fold when the frame hinge is not fully opened.

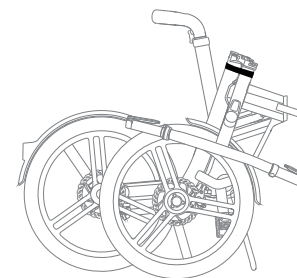
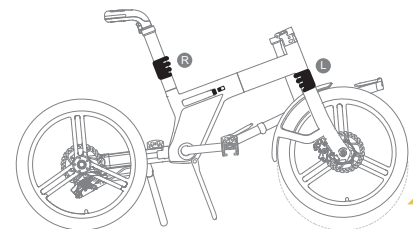

8. Hold the head tube with your left hand, and hold the seat tube with your right hand, lift the front wheel slightly and fold the frame clockwise.

# Unfolding

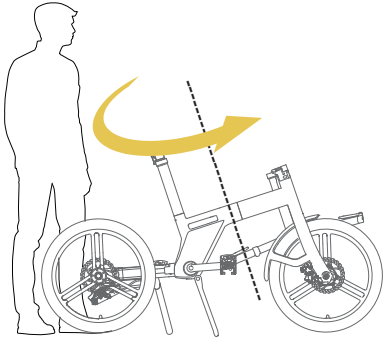

1. Stand on the left side of the bicycle and unfold the bicycle counterclockwise.

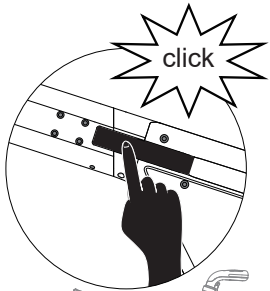

2. Use your palm to push the frame hinge to the bicycle frame until hearing a "click", indicating that the frame hinge is locked.

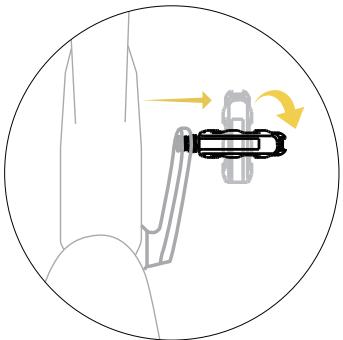
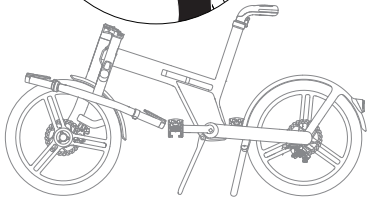

3. Push down on the folded part of the pedal with your palm until hearing a "click".

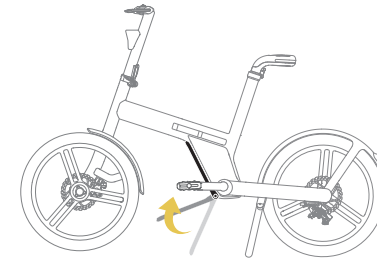

4. Pull the folding stand release inside the folding stand to the end and gently lift the folding stand.

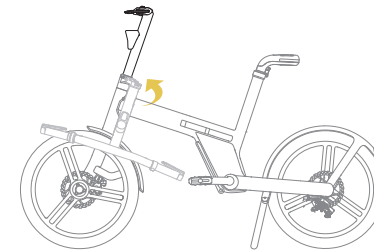

5. Flip the stem upward to the vertical position while paying attention to the brake cables to avoid interference when unfolding. Pull the hinge clamp downward to the lowest point and continue to push the stem to the vertical position.



6. Lift the hinge clamp up and firmly press it until hearing a "click", indicating that the hinge clamp is locked in place.

# Recommended torque values

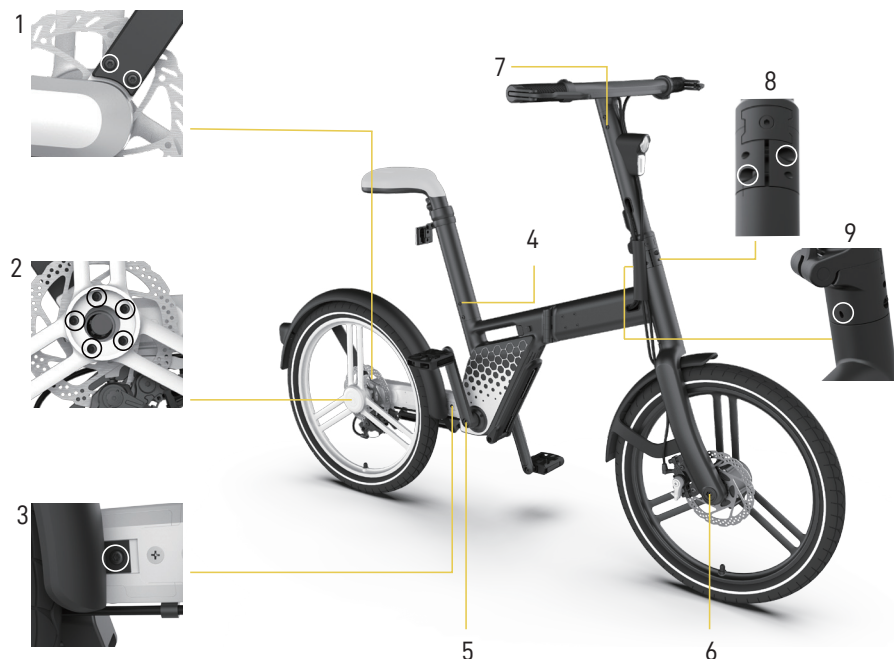

1	Rear fender bolts	4-6Nm	Hex key #4
2	Rear wheel bolts	13-15Nm	Hex key #4
3	Rear fender bolt	4-6Nm	Hex key #4
4	Saddle kit bolts	6-8Nm	Hex key #4
5	Crank arm bolt	40-45Nm	Hex key #8
6	Front fork bolt	23-28Nm	Torx key T30
7	Handlebar & stem bolts	6-8Nm	Hex key #3
8	Head tube bolts	13-15Nm	Hex key #5
9	Head tube bolt	13-15Nm	Hex key #4

Ensure correct setup, tightening, and torquing to recommended torque values is performed on your bicycle before first using it and check the setup, tightening, and condition of components and hardware regularly.

# Getting started



- 1. Battery power
- 2. Speed
- 3. Switch between km/h and mph
- 4. Walk mode
- 5. Pedal assist level
- 6. Mileage/Trip distance

- 7. Light
- 8. Bluetooth
- 9. Error indicator
- 10. Power button
- 11. Plus button/ Light button
- 12. Minus button/ Walk mode

The remaining battery capacity is an estimated value according to the current riding, the actual capacity is closely related to the user's riding habits, road conditions, and power-assist level selection.

## Display operations

Power on/off	Press and hold the Power button until the display is on/off
Power assist	Short press Plus button to increase the power assist level Short press Minus button to decrease the power assist level
Trip distance	The display shows single trip distance by default. Short press the Power button to check total distance.
Turn on/off the light	Press and hold the Plus button until the lights are on/off
Walk mode	Press and hold the Minus button

 The power will automatically shut off after 5 minutes if not being used.

 Only activate "walk mode" feature when pushing the bicycle.

## Display advanced settings

When the display is turned on, press and hold the Plus and Minus buttons at the same time to enter the advanced settings interface. Press and hold the Minus button for 2 seconds to quit the setup mode. After entering the setup mode, the interface will show P1 and the number 1 will blink. Press Plus or Minus buttons to switch between different parameter settings.

P1 - Metric/English system switching;

P4 - Adjust backlight brightness;

P5 - Auto power-off timer;

P6 - Single trip distance reset.

 In the advanced settings interface, if no operation is performed for more than 30 seconds, the system will automatically exit the setup mode and the current parameters will be automatically saved.

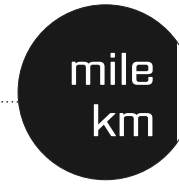

### MPH & KM/H (P1)

When the interface displays P1, short press the Power button first, then press the Plus or Minus button to switch between mile and km. After the setting is completed, short press the Power button to save the setting.



### Backlight brightness (P4)

When the interface displays P4, short press the Power button first, then press the Plus or Minus button to set the backlight brightness. 1 stands for the lowest brightness, and 5 stands for the highest brightness. After selecting the value, short press the Power button to save the setting.



### Auto power-off timer (P5)

When the interface displays P5, short press the Power button first, then press the Plus or Minus button to adjust the automatic shutdown time in minutes. 0 means that automatic power off function will be disabled. After completing the setting, short press the Power button to save the setting.



### Reset single trip distance (P6)

When the interface shows P6, short press the Power button, then press the Plus button to switch between "y" and "n". When the interface shows "y", short press the Power button to reset the single trip distance. After completing the setting, short press the Power button to save the setting.

## Pedal assist level



Level 0	No motor assistance
Level 1 & 2	Eco mode, low motor power assistance
Level 3 & 4	Normal mode, medium motor power assistance
Level 5	Sport mode, high motor power assistance

Honbike is equipped with smart sensor to provide automatic power assistance when going uphill.

 When riding the bicycle for the first time, we advise you to start from power assist level 1. When you are familiar with the bicycle and have experience riding it, then try higher levels. Higher levels mean higher speeds, so please keep your mind focused when riding the bicycle.

 Do not step on the pedals before sitting in the saddle, select the lowest drive assistance and be ready to brake when you set off. Risk of falling!

## Battery

The battery is located in the middle position of the frame. Four battery keys are provided along with the bicycle, please keep your keys in a safe place.

### Charging the battery



The battery can be charged on or off the bicycle. Gently open the rubber cover and insert the charger plug into the charging port to charge the battery. Put the rubber cover on after the battery is fully charged. When the display shows that the battery capacity is low, it needs charging immediately. When the battery is fully charged, a green light on the charger indicates the charge is complete. A complete charge will take about 3.5-4 hours.

Close the charge port lid to seal it against water and debris.

 Make sure that your bicycle, battery and charger are dry without any moisture visible before charging. If the bicycle, battery and charger are wet, wipe them with a clean cloth and wait until they are completely dry before charging.

 Do not move the bicycle during the charging process, as this may tangle the wires and cause danger.

 Please use the Honbike HF01 charger to charge the battery. Do not charge the battery with chargers other than the charger provided by Honbike. Honbike shall not be held responsible for any accidents caused by using other chargers not approved by us.



## Removing the battery

 Pull down the folding stand before removing the battery.

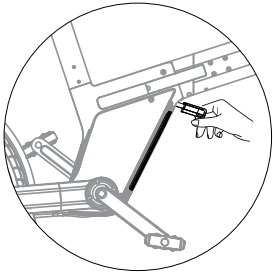

1. Insert the key.



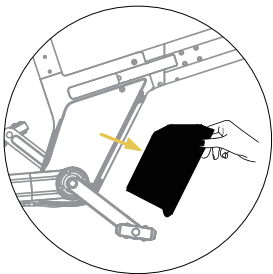

2. Hold the battery with your hand when unlocking the battery to prevent it from falling to the ground. Turn the key counterclockwise to open the battery lock.



3. Remove the battery and pull out the key.

4. Pull the folding stand release inside the folding stand to the end, and gently lift the folding stand.

 If your battery hits the ground and is damaged, please stop using it and contact us promptly.

 Each HF01 is equipped with a unique battery key, so please keep it safe and do not leave the key in the lock hole for a long time. If the battery key is lost, Honbike cannot provide you with a key that matches your bicycle and the battery will not be removable.

## Battery & Charger safety information

- In order to get the maximum life from your battery you should take care to use, store and recharge it correctly.
- The battery is generally not fully charged when the bicycle is stored and transported. So be sure to fully charge the battery before using it. If the battery is used without fully charging, its service life will be compromised.
- Disconnect the battery after it is fully charged, and do not charge it for more than 5 hours each time.
- Do not leave the battery unattended when it is being charged.
- Never charge your battery in a room that does not have an appropriate smoke detector. Make sure you can hear your smoke detector throughout your house.
- When charging, please place the battery in a safe place inaccessible by children.
- Battery charging and discharging conditions: the battery shall be charged at 10°C~25°C and discharged at 0°C~60°C
- Battery storage conditions: The battery shall be stored in a half state at the temperature of 15~25°C and relative humidity of no more than 75%.
- Before you stop using the bicycle or removing the battery from the frame, cut off the power supply of the bicycle first.
- When the battery is not used for a long time, please charge it for 30 minutes or to 75% every three months, to prevent over-discharging. Over-discharging will lead to permanent damage to the battery.
- The battery shall be protected from impacts, rain, water immersion, heat sources, destruction of appearance and short circuit of terminals.
- Do not use any used or second-hand lithium batteries that have not been approved by Honbike.
- In case of any obvious damage to its appearance, please stop using the battery.
- Riding in cold weather will reduce the range of the battery by up to 50%.
- The battery provided for HF01 shall not be used in an empty state. Honbike is not responsible for any problems caused by customers using empty batteries without permission. Do not dispose of any battery packaging materials.
- Please dispose of used batteries according to local laws and regulations. Do not dispose of any used batteries randomly to prevent environmental pollution.

- Please place the charger on a solid surface for charging and do not to cover it during charging. Do not place it on a carpet or textile surface or block its vents, as the charger may heat up during charging (up to 40-50°C).
- When using the charger, make sure there is no debris or flammable items around.
- The charger contains a HV circuit, so it is prohibited to disassemble or tamper with its power management system without permission; when using and storing the charger, liquid and metal particles should be prevented from penetrating into the charger, and the charger shall be protected from drops and impacts.
- Check the charger, charger cables, and battery for damage before beginning each charge. Do not use any damaged charger or plug for charging.
- Do not attempt to disassemble the battery. Risk of fire.

## Proper frame sizing

As the HF01 saddle adjustment range is limited, there is a certain restriction on the rider's height. HF01 is more suitable for riders in the height range of 1.5m to 1.9m, and we suggest you follow the method below for adjustment before riding. If the HF01 is not the right size for you, please do not try to maneuver it to avoid accidents.

Adjust the saddle height so that you can ride your bicycle comfortably. Sit on the saddle and place your foot on the pedal at its lowest point. Your leg should be mostly straight at this point with a slight bend at the knee.



## Intended use

HF01 is an electric bicycle developed in accordance with the requirements outlined in the Electric Bicycle Standard EN 15194. It is intended as a power-assisted bicycle for sensible use by physically competent consumers. HONBIKE products have been developed and designed for leisure and commuting usage in fair weather conditions, at speeds relevant to safe and appropriate travel in an urban or suburban environment, including but not limited to information contained in technical specifications, HONBIKE Owner's Manual, Assembly and Operation Guides, service communications and media accessible from [www.honbike.com](http://www.honbike.com)

The warranty will be void if your pedelec is not used in accordance with the intended usage.

Laws and regulations for e-bikes vary from country to country and region to region. We strongly recommend that you contact your local e-bike authority before riding it in public so that you are aware of the relevant laws and regulations.

## Road conditions suitable for this model

- This is a city e-bike equipped with city tires. This model is not intended for off road use.
- HF01 are only designed for one person riding with both wheels in contact with the ground on paved roads only. They are not intended for racing, jumps, hops, wheelies or anything of the kind. Using the bicycle for off-road riding, jumps or stunts may cause damage to the frame and risk injury or death to the rider.

 The manufacturer and dealer are not liable for damage or failures caused due to any direct or indirect use of Honbike HF01 which falls outside what is deemed intended or proper use.

- Please do not ride it on potholed sidewalks. Otherwise, falls or damage to the frame and wheels may be caused.
- If you are in a state of discomfort or recovering from a medical condition, consult your physician about the possibility of using an e-bike.

## Maximum permitted overall weight

HF01 can carry a maximum load of 100kg. Riding range and speed will be affected by the load carried by it, power assist settings, road conditions, tyre pressure and weather conditions.

 Exceeding the loading capacity will void all warranties and may result in unsafe operation of the product, which in turn may affect your life safety.

 Make sure you have good control of the e-bike carrying your luggage and keep it balanced. If you can't control it well, please reduce the weight of the luggage. Sudden shifts in load while riding can affect your balance and lead to serious injury or death. We recommend that you practice how to control the HF01 with luggage in a safe area before riding on public roads.

## How to increase riding mileage

Many conditions may affect the range of the bicycle, including load, riding speed, rider's pedal power, tire pressure and type, road conditions and weather conditions. Continuous use of motor assist and/or selecting the highest speed mode while riding will reduce the HF01 range.

To maximize the range of HF01, you can try the following method:

- Try to pedal as much as possible
- We recommend you to use the low assist gear or no-assist mode to ride the bicycle on flat roads or downhill roads, and select high power gear when riding against the wind, uphill and with heavier loads
- Try to keep the load to a minimum level
- Inflate the tires properly and keep the tire pressure within the normal range
- In case of poor road conditions (e.g., bad pavement, potholes or speed bumps), reduce the speed and adjust the riding modes.

 Ambient temperatures below +10 °C/50 °F and above +40 °C/104 °F can reduce the range.

## Before the first ride

 Before riding the bicycle, please read the manual carefully to make sure you understand each section of the manual. Familiarize yourself with the bicycle and its controls before riding in traffic.

### 1. Hinge and folding stand

- Check if the stem hinge and frame hinge are fixed, and if the frame is unfolded correctly in place before riding.
- Check whether the folding stand can be lifted and lowered normally. Make sure you have lifted the folding stand before riding.

### 2. Check if the seat tube bolts and rear fender bolts are tightened before riding.

### 3. Electrical system

- Make sure that you are familiar with the functions of all buttons and the meanings of the display information by referring to the content in the relevant sections of the electrical system.
- Before you set off for the first time, check whether the battery is fully charged, properly mounted and that it is locked.
- Check if the front light and rear light can be turned on normally and if the front and back reflectors are not damaged.
- Check if the display works normally.

### 4. Transmission system

- Push the bicycle forward and backward, check whether the front and rear wheels can rotate smoothly and whether there is any noise from the drive shaft to ensure that there is no stalling or unsteadiness during riding.

### 5. Tires

- Check tire pressure. Press the tires with your thumbs, which shall be solid and firm. If the tire pressure is insufficient, inflate to an air pressure of at least 3.4 - 3.6 bar (50 Psi), but over-inflation should be avoided.

### 6. Saddle

- Adjust the saddle to a proper height. Check that you can reach the floor with the tip of your toes when sitting on the saddle.
- Check if the seat post is locked tightly before riding to ensure that the saddle and seat tube are securely fastened.

## 7. Brake

- During the assembly at Honbike, the right brake lever is used to control the rear brake and the left brake lever is used to control the front brake. Check if the brake setting could match with your habit. Try to use the rear brake first when braking.

 In the UK, China and Japan, the brake setting is different with the left brake lever for rear brake and the right brake lever for front brake.

- Stand next to the bicycle, pull the left and right brake levers at the same time and push the bicycle forward, the brake discs should be able to prevent the wheels from moving.
- You need to try braking on a flat, non-slip surface to make sure you can get used to the braking effect of the HF01 before riding it in traffic on a public road.

## 8. Pedals

- Check whether the pedals are tightened onto the cranks and whether they can be folded and unfolded normally. Make sure that the pedals are unfolded before riding.

# Before every ride

Your Honbike HF01 will be double checked at the factory, but due to factors such as potential shipping or tampering by a third party, we recommend you check the following items before each ride to troubleshoot any faults:

- Check whether the folding stand and parking stand can be lifted and lowered normally.
- Check whether the front stem hinge, frame hinge mechanism and seat tube lock are fixed and locked firmly.
- Check if the battery is installed and locked, and if it is fully charged and capable of supporting your planned trip.
- Check if the bicycle can move forward and backward smoothly.
- Check if the front light and rear light can be turned on normally and the front and rear reflectors are not damaged.
- Check if the tires are in good condition, and have sufficient pressure.
- Check the display for any warnings or error messages. Resolve the error before riding. Check if the display buttons can be operated normally.
- Check if the brakes work normally.
- Check if the seat tube and fender bolts are tightened.
- If you decide to cycle on public roads, you should equip your bicycle according to the legal requirements in your country.

As you cannot inspect a shaft drive, there is not much you can check before a ride.

# Safety

 This section covers safety-related information, so please read it carefully before riding.

## The basics

- Please comply with the local road and traffic laws in your country or region.
- Wear a helmet that meets the latest safety testing standards, and follows the helmet manufacturer's instructions for use. It may help prevent injury in an accident.
- Wear appropriate safety equipment according to the riding you plan to do.
- Do not ride while intoxicated or while using medications that can make you drowsy or less attentive.
- Refer to the previous two sections to check the bicycle before riding it.
- Brake discs will become hot during use and will stay hot for a short period of time. Ensure you do not touch the discs right after use.
- Do not park the bicycle in building lobbies, on evacuation stairs, fire exits or on sidewalks.
- Once you have come to a stop, do not apply pressure to the pedals, this could engage the power assist function. Or you can hold the brake lever firmly to ensure that the power is cut off.
- During folding and unfolding, as well as during use and maintenance, avoid putting your hands or fingers anywhere they may be caught or trapped.
- It is recommended that the bicycle shall be used by users over 16 years old, younger users must use the bicycle under the guidance of an adult or guardian.
- Only use the supplied charger cable and plug. Ensure the charger cable is fully inserted in the charger before connecting the charger to a power outlet. Plug the charger's plug into an outlet (100-240V), using the appropriate plug / adaptor for the country's standards, then connect to the charging socket on the battery.
- If there is any damage to the protective layer of the wire harness of the bicycle, please contact Honbike as soon as possible to prevent injury to the user.

## Safe riding

- During the ride, please stay focused, watch out for passing pedestrians and vehicles, and keep a safe distance.
- During the ride, please do not hang anything on the handles to avoid losing control of the bicycle and causing an accident.
- When braking, please avoid sudden braking, try to reduce speed slowly. Please use the rear brake first, and then the front brake. Do not brake too hard. Braking sharply on the front wheel may cause the bicycle and rider to lose grip and cause injury, and braking sharply on the rear wheel may cause a change of direction and injury.
- Please keep a reasonable safe distance while riding between yourself and motor vehicles. Do not follow them too closely as they may slow down and turn at any time.
- When riding, keep a distance from motor vehicles parked on the roadside and be aware of car doors opening suddenly to avoid crashing into them.
- Please do not wear earphones or headphones that can affect your hearing during the ride.
- Please ride along in a straight line in designated bicycle lanes. Please ride with the flow of traffic and do not travel against it.
- It is prohibited to ride up and down stairs or jump over any obstacles on the HF01.
- It is forbidden to ride without holding the handles or when holding an umbrella. Failure to keep your balance may result in an accident.
- Do not use HF01 with bicycle trailers, mounts, frames or accessories that have not been tested for safety and compatibility standards by Honbike.
- After any accident, you must consider that the current HF01 is unsafe. Contact Honbike for a maintenance check, and confirm that it is safe before you can ride the HF01 again.
- Ride defensively. Make others aware of your presence and avoid entering any vehicle's blind spot. Remember to avoid accidents by using your bicycle bell and brakes.
- Do not ride while intoxicated or while using medications that can make you drowsy or less attentive.

## Riding in bad weather conditions

- Rain, snow, slippery roads and other conditions will affect the braking effect and increase the braking distance, so please brake early in these situations.
- Riding on slippery roads can make it difficult for you and other riders to control speed, and you are more likely to slip in turns. So you need to stay alert, watch out for oncoming vehicles, reduce your speed and make sure you can brake safely.
- When you are wearing a raincoat, pay close attention to avoid the raincoat being caught in the wheels or being hooked by any stationary or moving vehicles.
- Try not to ride in heavy rain and standing water. If it is cold, and the temperature is near or below the freezing point, pay attention to ice on the road and avoid drain/ man hole covers.
- Honbike HF01 can withstand light rain and small splashes. The electrical parts of HF01 have an Ingress Protection rating of IP65. But it does not mean that the bicycle and its mechanical and electrical components are waterproof. We do not recommend storing or using the bicycle in excessively wet conditions. The warranty for the HF01 does not cover water damage.

## Riding in low light conditions

- Riding at dusk, at night, or in any poor light conditions is much more dangerous than in daytime, please ride more cautiously, and choose appropriate products to aid your vision and make yourself more visible.
- Ensure your front and rear lights are turned on and adjusted such that other people on the road can see them clearly.
- Make sure both front and rear reflectors are clean, undamaged and visible before riding off.



Removing lights and reflectors can reduce your visibility to others and could result in an accident that may cause injury or death.

## Maintaining your Honbike



Please visit the official website at [www.honbike.com](http://www.honbike.com) for the latest and important information about products, manuals and maintenance activities before trying to maintain your HF01.

Compared with conventional ebikes, the Honbike HF01 is low maintenance with fewer complicated parts that require less attention for simplicity. After riding for a period of time, like any bicycle, some parts may loosen, wear or become damaged, so inspection and maintenance at regular intervals will extend the service life of your HF01 and prevent damage and potential accidents. Store your Honbike HF01 in a clean, dry place to avoid rust and corrosion.

The maintenance of HF01 is generally divided into the following tasks:

- **Cleaning:** Wipe the whole bicycle and parts with a damp rag and a low residual cleaner. Dry your HF01 thoroughly after cleaning to prevent corrosion and rust. Remove any oil residue on the brake discs.
- **Inspection:** Brakes, tires and lights should be inspected regularly. Please refer to the sections "Before the First Ride" and "Before Every Ride".
- **Tightening:** The fasteners of the whole bicycle should be tightened periodically by referring to the section of **Recommended Torque Values**.
- **Lubricate:** Clean and lubricate the following moving parts regularly.

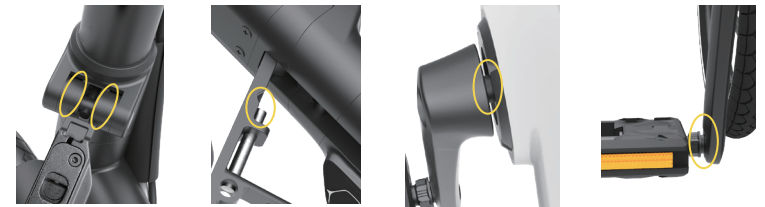

- **Adjustment:** Brakes should be adjusted periodically. Ensure front and rear brakes work properly. Check brake cable tension, replace brake cables if necessary.

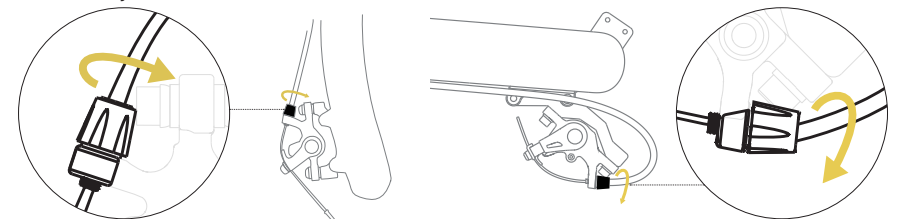

- **Replacement:** If a part is damaged or unusable or has any cracks, scratches or color changes, the part has reached the end of its service life and should be replaced promptly.

## Service interval

The user shall be responsible for safe riding and regular maintenance. Your bicycle needs a regular service. Below is our recommended service frequency based on how often you ride.

### Monthly (or every 500kms/ 300 miles )

- Check tire pressure. Press the tires with your thumbs, which shall be solid and firm. If the tire pressure is insufficient, inflate to an air pressure of 3.4-3.6 bar, avoid over inflating your tyres.
- Clean and lubricate moving parts regularly.
- Check that all hardware is tightened to the torque specifications listed in the **Recommended Torque Values** section of this manual.
- Check your brake pads for signs of wear. Replace if necessary.
- Check the frame, front fork and kickstand for any damage, deformation or cracks.
- Check all wiring harnesses (such as brake wires, front light wires and rear light wires) of the whole bicycle for any damage or wear.
- Check the charger and its wiring harness for damage and check if the bicycle can be charged normally.

### Quarterly (or every 1500kms/ 900miles)

- Check all items on the monthly service list above.
- Check tire tread for excessive wear. Replace if necessary.
- Check and update to the latest firmware version.



This maintenance interval is based on normal usage. If you ride your Honbike HF01 more than average, or in rain, snow, or bad road conditions, maintain your bicycle more often than the suggested interval.

## Replacing parts

Except for the tires, brake pads and brake discs that are commercially available in the market, all other parts of HONBIKE HF01 are specially designed by Honbike. If your parts fail, please contact Honbike for support.

(Tire: 20 x 2.125; Brake disc: diameter  $\varnothing$  160mm)

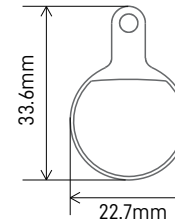

Front brake pad  
Thickness: 4mm

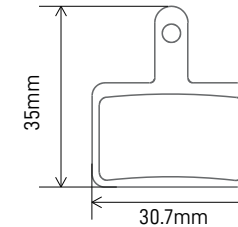

Rear brake pad  
Thickness: 4mm

Other parts: brake levers, grips, bell, crank, folding pedals, folding stand, front fender, rear fender, front light, rear light, disc brakes, brake pads, kickstand, saddle & seat post set, charger.



Please use Honbike original parts only. If you use parts not approved by Honbike, you will solely be responsible for any consequences, damage or accidents caused.

## Maintenance notes

- Please do not replace any parts or change battery capacity or motor power unless instructed to do so by Honbike to avoid damage and danger. If you have made any changes without permission, you shall solely be responsible for any consequences.
- Honbike HF01 is equipped with a high speed motor, when you roll the bicycle backward, you will feel resistance at the front hub motor and may accompany with a sound, which is normal; when you are pushing the bicycle forward, this phenomenon will not occur. If the motor makes a sound when the bicycle is pushed forward, it means the internal clutch of the motor is malfunctioning, please contact us as soon as possible.
- When cleaning Honbike HF01, do not pour water directly on the bicycle to prevent water from entering some parts and affecting the performance and life of the bicycle; do not use steam or high-pressure water guns when washing the bicycle.
- After cleaning the bicycle or riding it in water, pay special attention to the working condition of the brakes. Cleaning it with water or riding it in water may reduce the braking effect. In such case, you should ride slowly and pay attention to your safety.

# Warranty

Please go to [www.honbike.com](http://www.honbike.com) to view the latest warranty terms.

Honbike warrants each new frame, front fork, handlebar, and original components against defects in workmanship and materials

For two years:

- Frame, Front fork and Handlebars

For one year:

- All original parts, such as battery, charger, motor

This warranty is expressly limited to the repair or replacement of a defective item and is the sole remedy of the warranty. This warranty commences from the date of purchase.

Claims under warranty will only be valid with proof of purchase and frame number of Honbike products through the Honbike official website or Honbike authorized dealers for the original owner only. Warranty is not transferable.

## Register your Honbike

To ensure the validity of your warranty, please register your account and your bicycle through the Honbike APP before you use your Honbike. This enables us to contact you if needed and provide important information related to the safety of our products.

-  The Owner's Manual is labeled with a unique frame number and validation number on the back. Please keep the two numbers safe. They are proof of your bicycle ownership.

## Warranty notes

- Users shall follow the instructions for proper operation and use of the bicycle. Any unreasonable, reckless use or modifications may invalidate the warranty.
- Our company will perform warranty obligations for any performance failures caused by product quality issues.
- Should a product defect become known, the owner should stop riding the bicycle and transport the bicycle or part(s) to Honbike for warranty repair (within the applicable warranty period). The transport of the bicycle or any bicycle part to and from Honbike is the owner's responsibility and at the owner's expense.

-  Please visit [Honbike.com](http://Honbike.com) to find out how to pack your Honbike HF01 to ensure safe transport.

- Upon receiving your bicycle, please check and test it immediately. We will replace any parts deemed to have been damaged during shipping. Shipping damage must be reported to Honbike within 5 working days of shipment arrival, please preserve evidence of any damage. This applies to all products including bicycles and accessories. You will NOT be refunded or compensated for your time or labour replacing damaged parts.
- Bicycles or parts returned without proper documentation may result in delayed service or denied warranty coverage. Warranty return shipping costs along with duties and taxes are the responsibility of the claimant. All unauthorized returns will be refused.



## Exclusions

- Malfunction due to the user's failure to use, maintain and adjust the bicycle in accordance with the provisions of the Owner's Manual.
- Malfunction caused by the user's unauthorized assembly, change or addition of parts and non-compliance to the user rules.
- Malfunction caused by improper installation, use, or storage by the user, or by collision.
- Bicycles for which proof of purchase, frame number and other relevant documents cannot be provided.
- Normal wear and tear on parts such as tires, brake pads and paint are not covered by the warranty.
- Damage caused by water such as rusting and or corrosion.
- Bicycle loss or theft.

## Special notes

Our liability is limited to repair or replacement of the product. If you need any repair service outside of the warranty period, you will be charged for the appropriate parts, labor and shipping costs.

In the event of a conflict between this warranty statement and the laws in force at the place of sale, the laws in force shall prevail. Our company reserves the right to amend the above terms and conditions without prior notice. If any part of this warranty does not comply with local law, then it shall be deemed separable from the rest of this warranty, which remains enforceable and shall be interpreted as the closest meaning of that written above, in English, or the minimum required by such local law.

This warranty does not affect the statutory rights of the consumer.

## Disclaimer

### Declaration of conformity

This declaration relates exclusively to the machinery in the state in which it was placed on the market and excludes components which are added and/or operations carried out subsequently by the final user. The declaration is no longer valid if the product is modified.

Honbike declares that HF01 conforms to the requirements of: Machinery Directive (2006/42/EC), the EMC Directive (2014/30/EU), and the Radio Equipment Directive (2014/53/EU), and DIN EN 15194:2017.

### Federal Communications Commission (FCC) Compliance Statement for USA

This device complies with part 15 of the FCC rules.

Caution: Changes or modifications not expressly approved by the party responsible for compliance could void the user's authority to operate the equipment.

Operation is subject to the following two conditions: (1) This device may not cause harmful interference, and (2) this device must accept any interference received, including interference that may cause undesired operation.

Note: This equipment has been tested and found to comply with the limits for a Class B digital device, pursuant to part 15 of the FCC Rules. These limits are designed to provide reasonable protection against harmful interference in a residential installation. This equipment generates, uses, and can radiate radio frequency energy; if not installed and used in accordance with the instructions, it may cause harmful interference to radio communications. There is no guarantee that interference will not occur in a particular installation. If this equipment does cause harmful interference to radio or television reception, which can be determined by powering the equipment off and on, the user is encouraged to try to correct the interference by using any of the following measures:

- Reorienting or relocating the receiving antenna.
- Increasing the separation between the equipment and receiver.
- Connecting the equipment into an outlet on a circuit different from that to which the receiver is connected.
- Consult the dealer or an experienced radio/TV electronics technician for help.

## Prop 65 Warning

This product can expose you to chemicals including lead, which is known to the State of California to cause cancer and birth defects or other reproductive harm. For more information go to: <http://www.p65warnings.ca.gov>.

## Liability Disclaimer

The specifications, information and performance regarding the HF01 in this document are subject to change without notice. It is the buyer's and/or rider's responsibility to determine the correct and safe selection of settings and conditions of use of the products and to periodically check the products for secure and proper operation.

To the extent that the law permits, any liability which may be incurred as a result of the use of a product manufactured by or sold under license granted by Honbike is limited to the cost of repairing or replacing the failed product or component at the discretion of Honbike, either within or outside of warranty periods, and does not extend to any loss or damage which may be caused as a consequence of misuse or failure of the products.

## Legal

The HF01 is a 250W pedal-assist electric bicycle (Pedelec). Each country has its own guidelines around cycling, which we highly recommend reviewing before riding your Honbike.

If you want to use your bicycle on public roads, it has to comply with the respective legal requirements. These requirements may vary in each country. The fittings of your pedelec are, therefore, not necessarily complete. Inform yourself about the laws and regulations applicable in your country or in the country you intend to use the HF01 pedelec. Have your pedelec equipped accordingly before using it on public roads.

Frame Number

Validation Code